

RIGOL

Quick Guide



© 2014 RIGOL Technologies, Inc. All Rights Reserved.

DSA800

DSA800 Series Spectrum Analyzer

General Inspection

1. Inspect the shipping container for damage

If your shipping container appears to be damaged, keep the shipping container or cushioning material until you have inspected the contents of the shipment for completeness and have checked the instrument electrically and mechanically. If your instrument has been damaged during shipping, please contact your shipper and carrier for compensation. **RIGOL** will provide no free repair or replacement.

2. Inspect the instrument

If there is any mechanical damage or defect, or if the instrument does not pass electrical and mechanical tests, please contact your **RIGOL** sales representative.

3. Check the accessories

Please check the accessories according to the packing lists. If the accessories are incomplete or damaged, please contact your **RIGOL** sales representative.

General Safety Summary

1. Use power cords designed for the instrument and authorized by local country.
2. Make sure the instrument is grounded properly.
3. Do not operate without covers.
4. Use proper fuse.
5. Avoid circuit or wire exposure.
6. Do not operate with suspected failures.
7. Keep proper ventilation.
8. Do not operate in wet conditions.
9. Do not operate in flammable and explosive environment.
10. Keep product surface clean and dry.
11. Protect the instrument from static electricity.
12. Pay attention to handling safety.

Product Overview

DSA800 series spectrum analyzers which are small, light and cost-effective, are portable spectrum analyzers designed for starters. It mainly includes DSA815, DSA832 and DSA875 three models. Configured with easy-to-operate keyboard, high-resolution color LCD display and various remote communication interfaces, they can be widely used in various fields, such as education, company research and development as well as industrial manufacture.

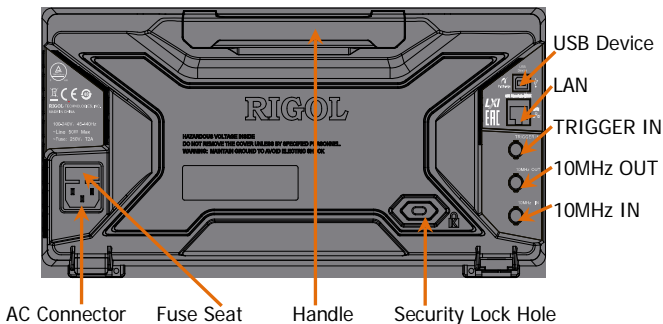
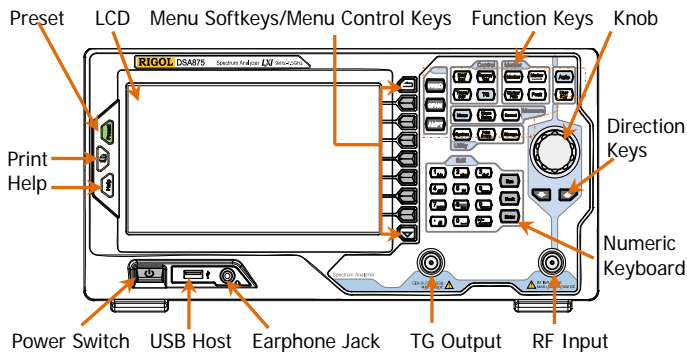

To Adjust the Supporting Legs

Users can unfold the supporting legs to use them as stands to tilt the instrument upwards for easier operation and observation. Users can also fold the supporting legs when the instrument is not in use for easier storage or shipment.

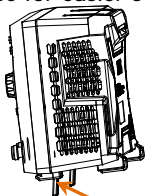

Unfold the Supporting Legs

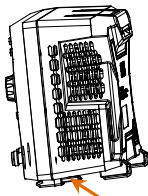

Fold the Supporting Legs

To Connect Power

Connect the spectrum analyzer to AC power source using the power cord supplied with the accessories. DSA800 supports 100 V - 240 V, 45 Hz - 440 Hz AC power source and 5 mm×20 mm, 250V AC, T2A fuse.



CAUTION

Make sure that the instrument is properly grounded to avoid electric shock.

Start-up and Self-calibration

After connecting the instrument to power source correctly, press  at the front panel to start the spectrum analyzer. You can obtain information about the start-up initialization process through the start-up progress indications. Following the start-up screen, the sweep curve is displayed. Press **System** → **Calibrate** → **Cal Now** and the instrument will perform self-calibration using the internal calibration source (for more information, refer to the *DSA800 Series User's Guide*).

Using Notices

1. To use the tracking generator output terminal:



CAUTION

To avoid damage to the tracking generator, the reverse power cannot exceed +10 dBm when the frequency less than 10 MHz; the reverse power cannot exceed +20 dBm when the frequency more than 10 MHz. The reverse DC voltage cannot exceed 50 V.

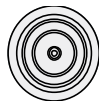

GEN OUTPUT 50Ω
MAX 50V DC

2. To use the RF input terminal:





CAUTION

To avoid damage to the instrument, for the signal input from the RF input terminal, the DC voltage component and the maximum continuous power of the AC (RF) signal component cannot exceed 50 V and +20 dBm respectively.



RF INPUT 50Ω
MAX+20dBm/50V DC

Remote Control Overview

DSA800 supports communication with PC via USB, LAN or GPIB (option) interface for remote control. The remote control is realized on the basis of SCPI (Standard Commands for Programmable Instruments) command set through two ways: user-defined programming and PC software (such as **RIGOL Ultra Sigma**). When the instrument is in remote mode, the  icon is displayed in the user interface and the front panel keys (except ) are locked. At this point, you can press  to exit remote mode.

For More Product Information

You can obtain the instrument information including model, serial number as well as hardware and software version numbers through **System** → **Information** → **System Info**. You can also view the list of installed options through **System** → **License**. For more information of this product, please refer to the following manuals (provided in the “CD” in the accessories; you can also download them from the **RIGOL** network):

DSA800 Series User’s Guide: provide detailed introductions of the functions of this product;

DSA800 Series Programming Guide: provide detailed introductions of the SCPI commands and programming of this product;

DSA800 Series Datasheet: provide the main characteristics and specifications of this product;

DSA800 Series Accessories and Options: provide detailed introductions of the accessories and options of this product.

Contact Us

If you have any problem or requirement when using our products or this manual, please contact **RIGOL**.

E-mail: service@rigol.com

Websites: www.rigol.com

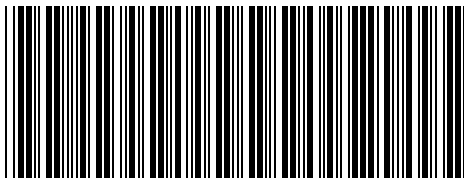

ZN1020002759